

SISTEM KOMUNIKASI OPTIK

- **MATERI 5**
- **DISPERSI MODE POLARISASI**

- D3 Teknologi Telekomunikasi – Fakultas Ilmu Terapan



PULSA OPTIK

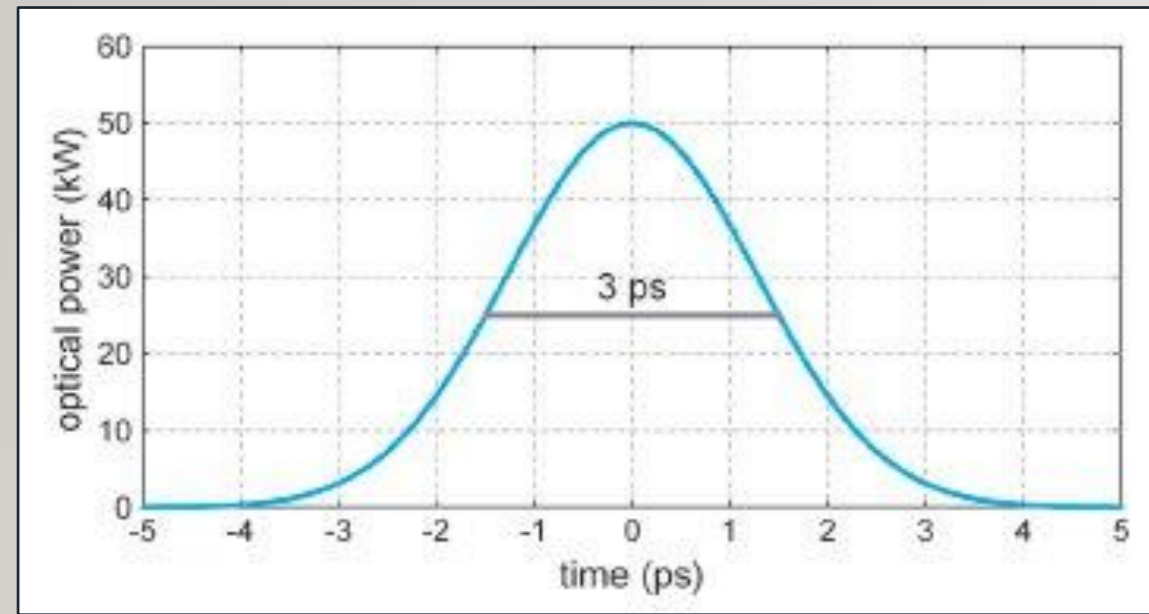

Gambar 1. Pulsa Optik

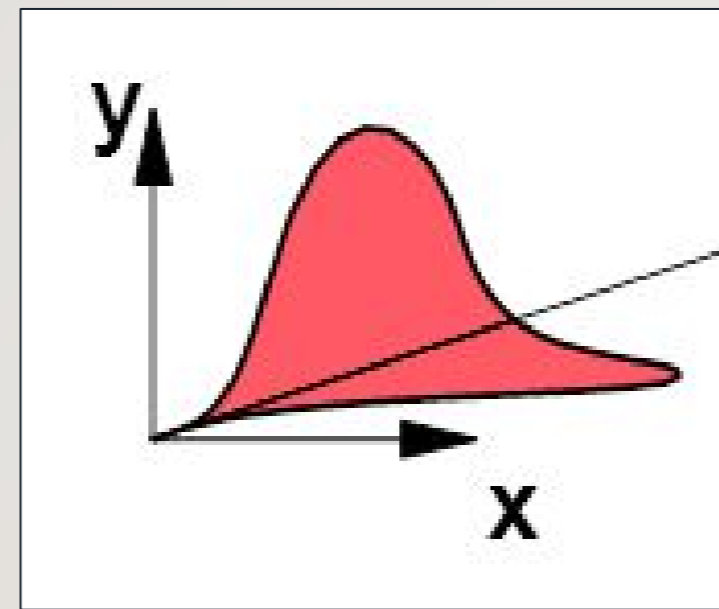

Gambar 2. Polarisasi Pada pulsa Tunggal

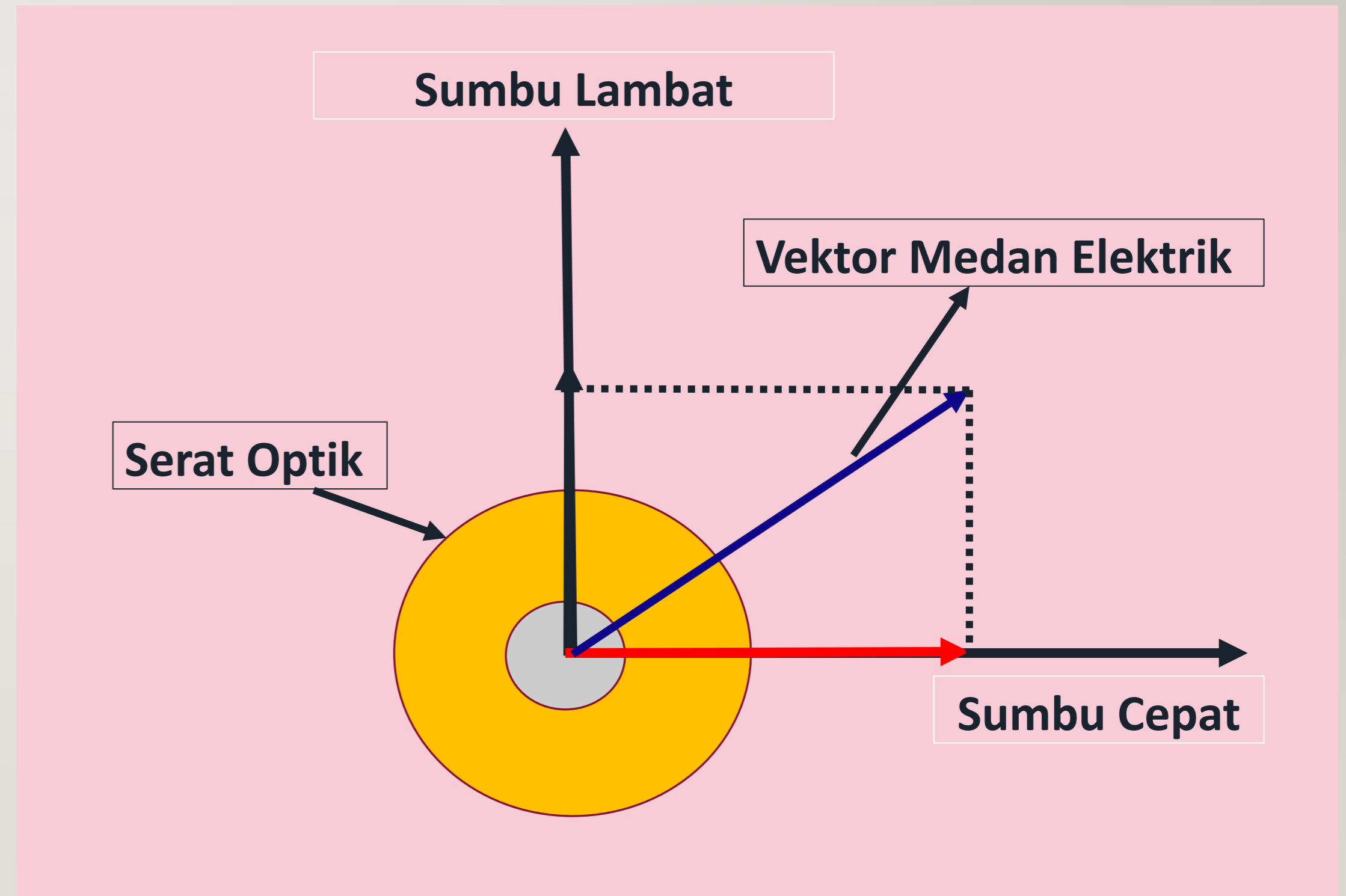

Gambar 3. Vektor Medan Elektrik

DISPERSI MODE POLARISASI

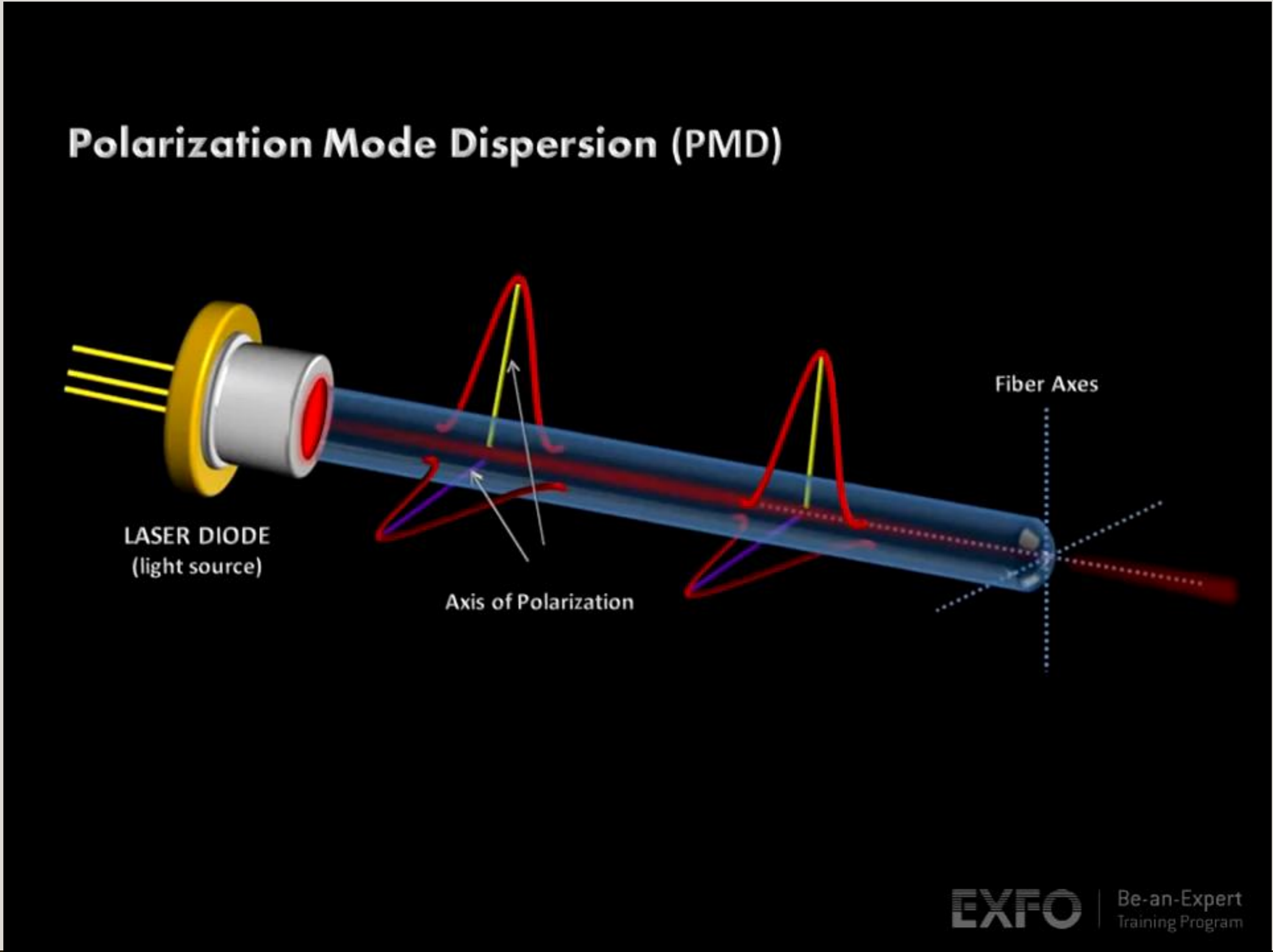

PENYEBAB DISPERSI MODE POLARISASI

1. Saat proses fabrikasi atau pembuatan serat yang kurang sempurna

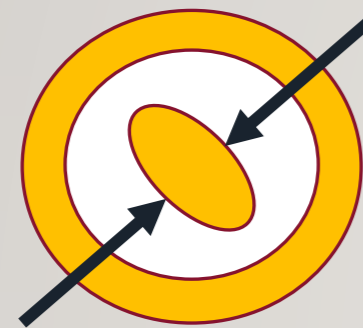

Core Tertekan

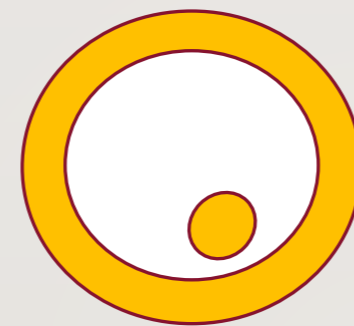

Cladding Eccentricity



Elliptical Fiber Design

2. Mechanical Stress

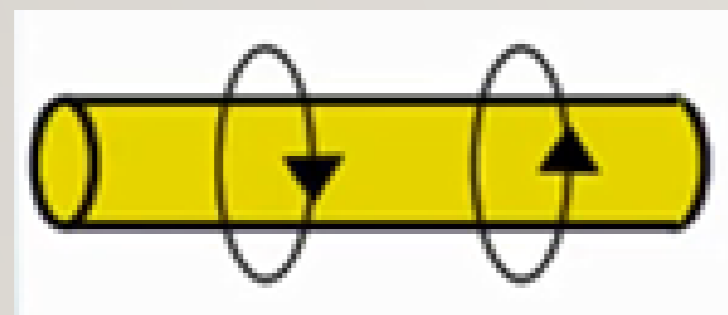

Serat Memutar

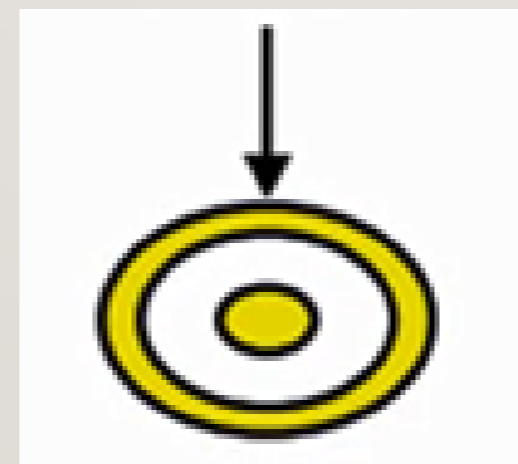

Serat Tertekan

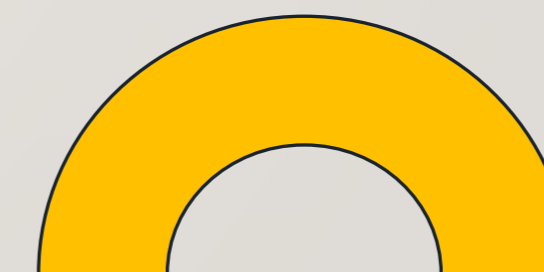

Serat Melengkung atau Terlekok

PENGARUH DISPERSI MODE POLARISASI

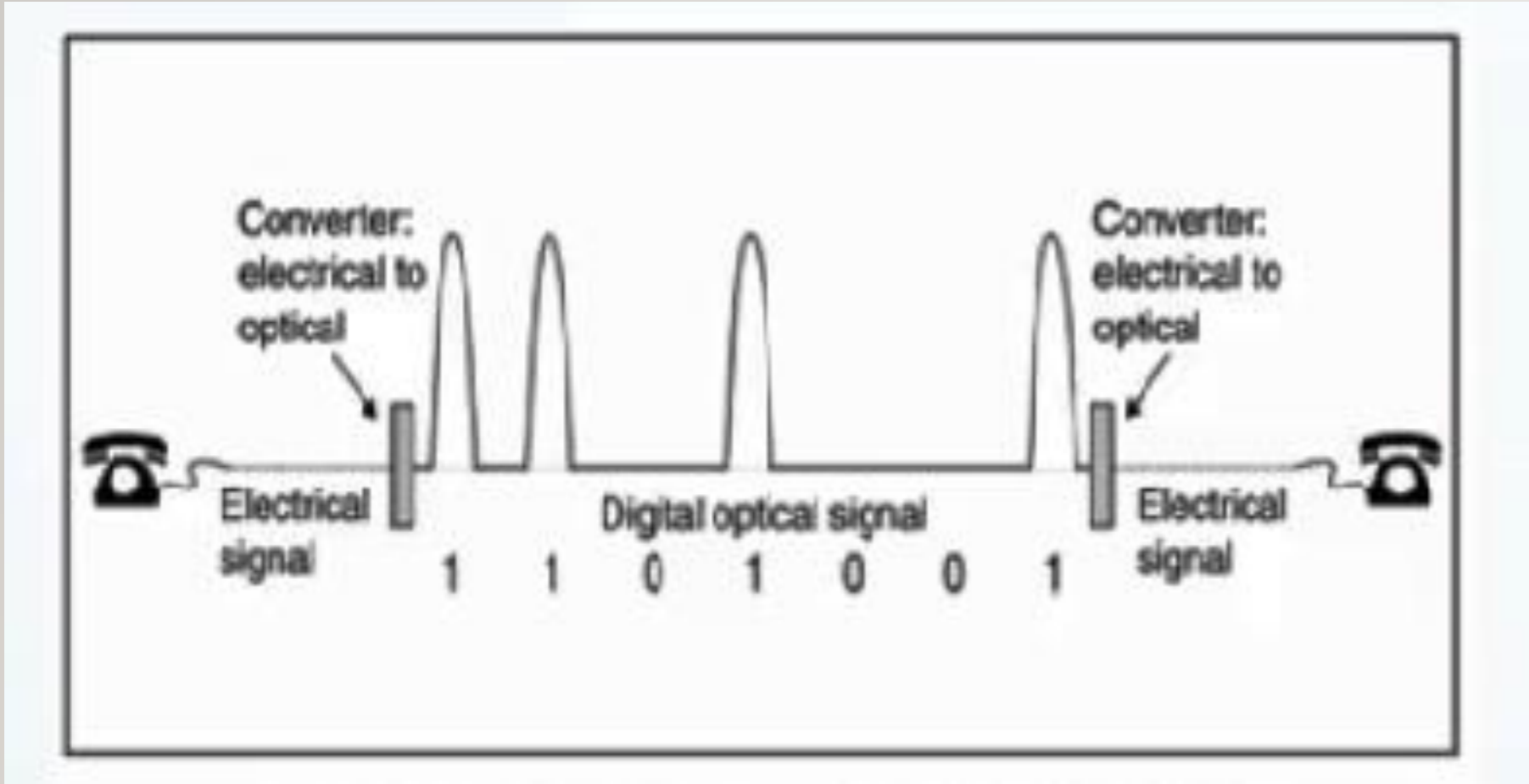

Gambar 1. Pulsa Sinyal pada 2.5 Gb/s tanpa Dispersi Mode Polarisasi

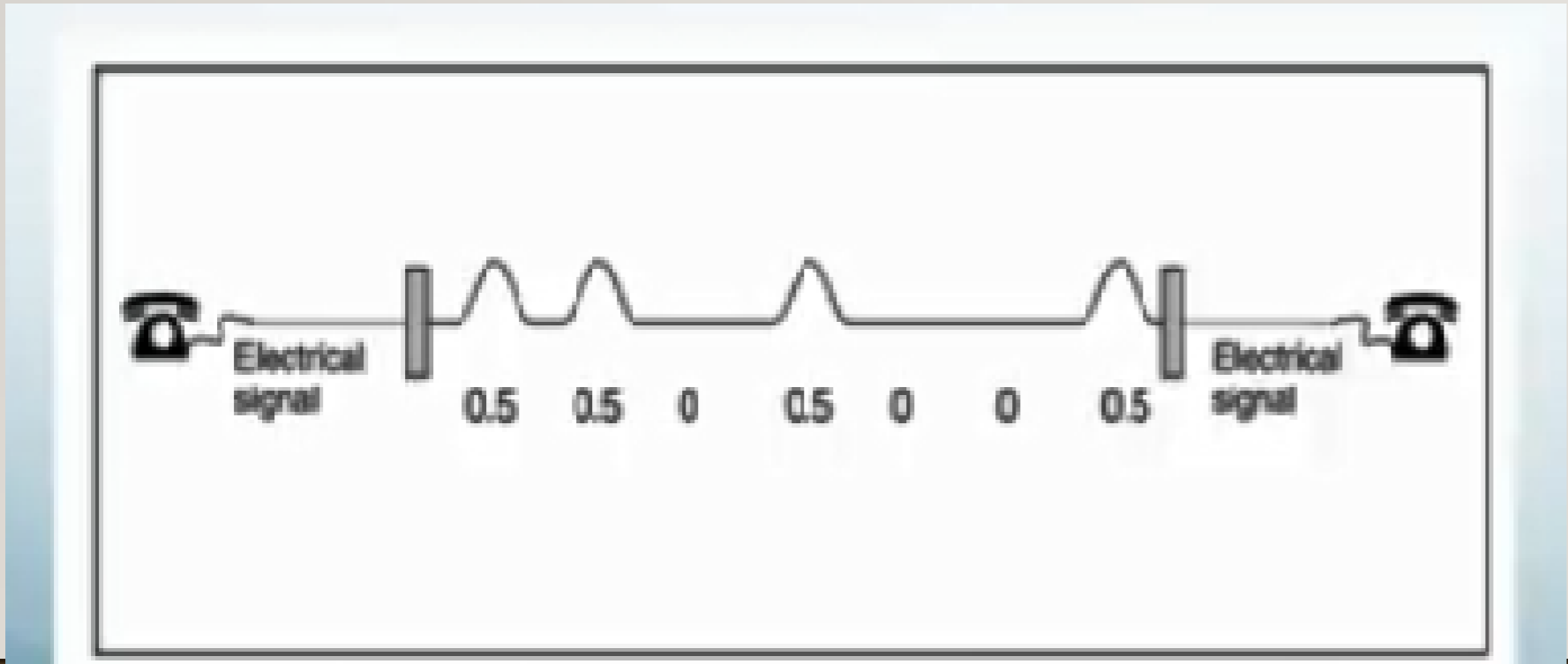

Gambar 2. Pulsa Sinyal pada 2.5 Gb/s Dengan Dispersi Mode Polarisasi

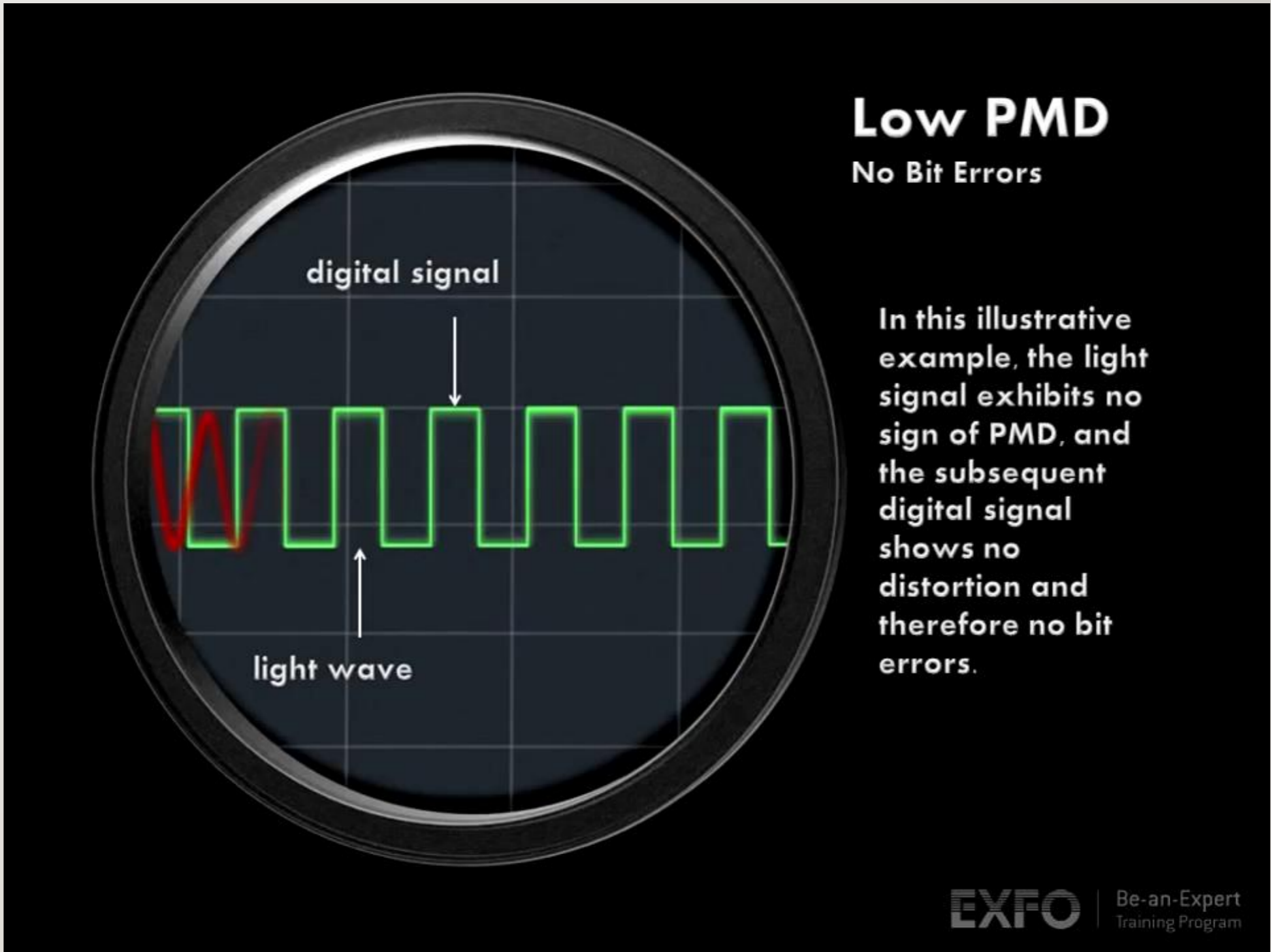

Gambar 3. Pulsa Sinyal Dengan Dispersi Mode Polarisasi rendah

Sumber Referensi https://www.youtube.com/watch?v=J4-wCa_VNfA&t=47s
<https://www.youtube.com/watch?v=DKCHYUyXYXo&t=1s>
Gerd,Keiser.,2010, *Optical Fiber Communications*, 4th edition,McGraw Hill, International Edition

PENGARUH DISPERSI MODE POLARISASI

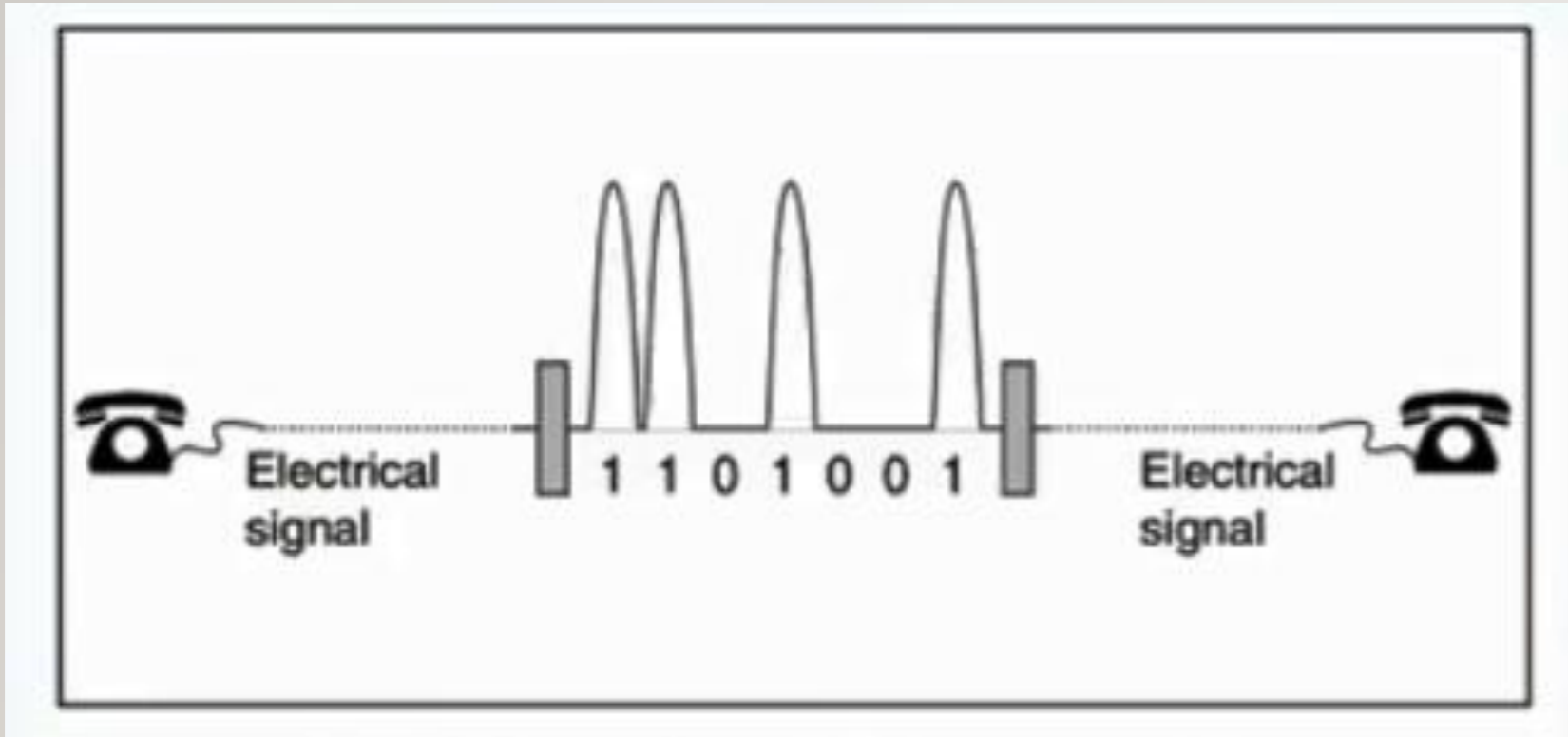

Gambar 1. Pulsa Sinyal pada 10 Gb/s tanpa Dispersi Mode Polarisasi

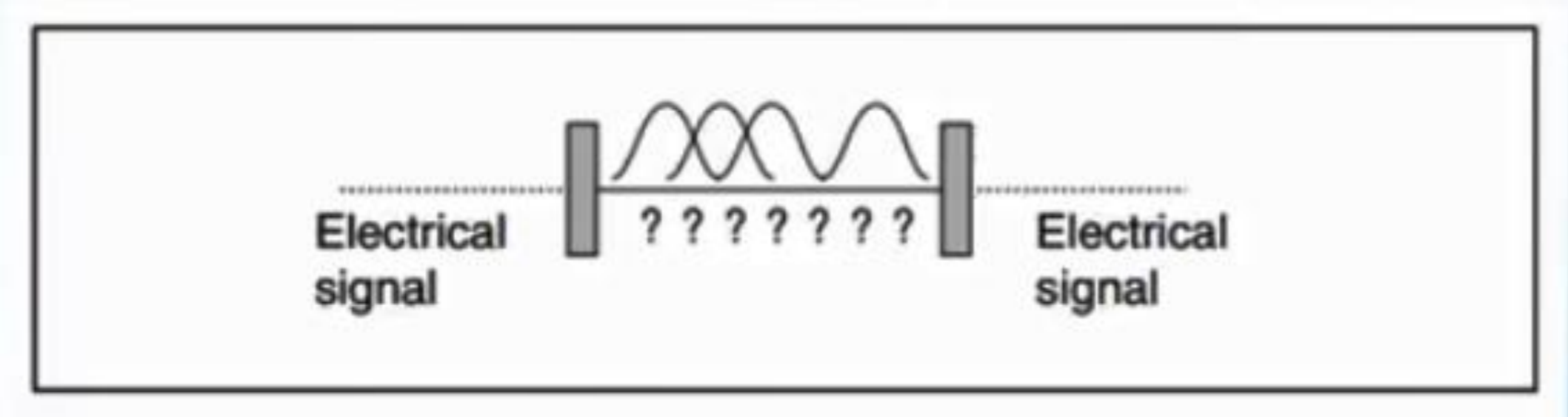

Gambar 2. Pulsa Sinyal pada 10 Gb/s Dengan Dispersi Mode Polarisasi

Gambar 3. Pulsa Sinyal Dengan Dispersi Mode Polarisasi Tinggi

*Sumber Referensi https://www.youtube.com/watch?v=J4-wCa_VNfA&t=47s
<https://www.youtube.com/watch?v=DKCHYUxYXo&t=4s>
 Gerd,Keiser.,2010, *Optical Fiber Communications*, 4th edition,McGraw Hill, International Edition



TERIMA KASIH



UNITED STATES OFFICE

1243 Barker Cypress
San Francisco, California



EUROPE OFFICE

13 Ave. Ballarta
Barcelona, Spain



SOUTH AMERICA OFFICE

45 Calle Norte
Argentina

