

SISTEM KOMUNIKASI OPTIK

- **MATERI 14**
- **SISTEM PERANGKAT UTAMA VLC**
- D3 Teknologi Telekomunikasi – Fakultas Ilmu Terapan

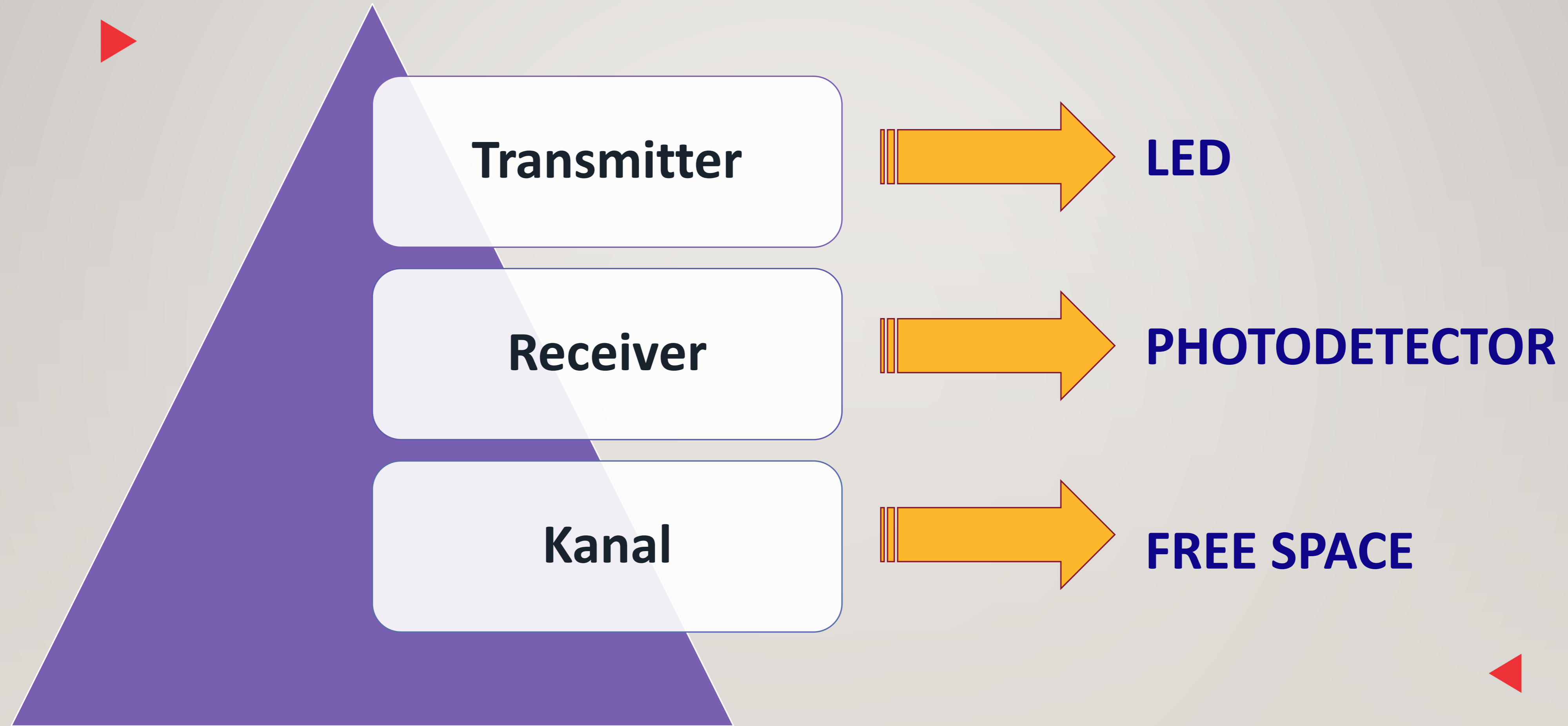

SISTEM PERANGKAT UTAMA VLC



TRANSMITTER VLC

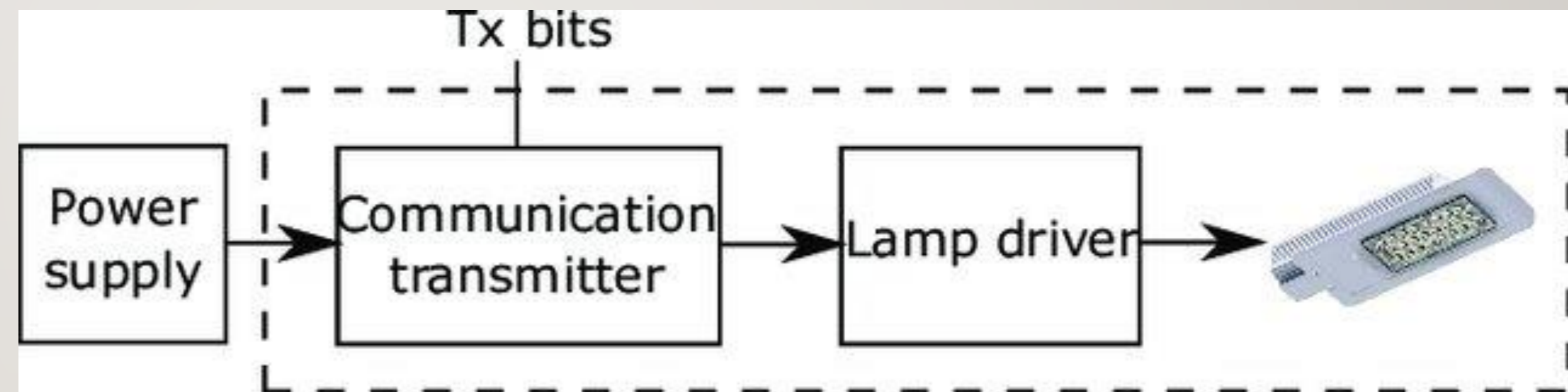
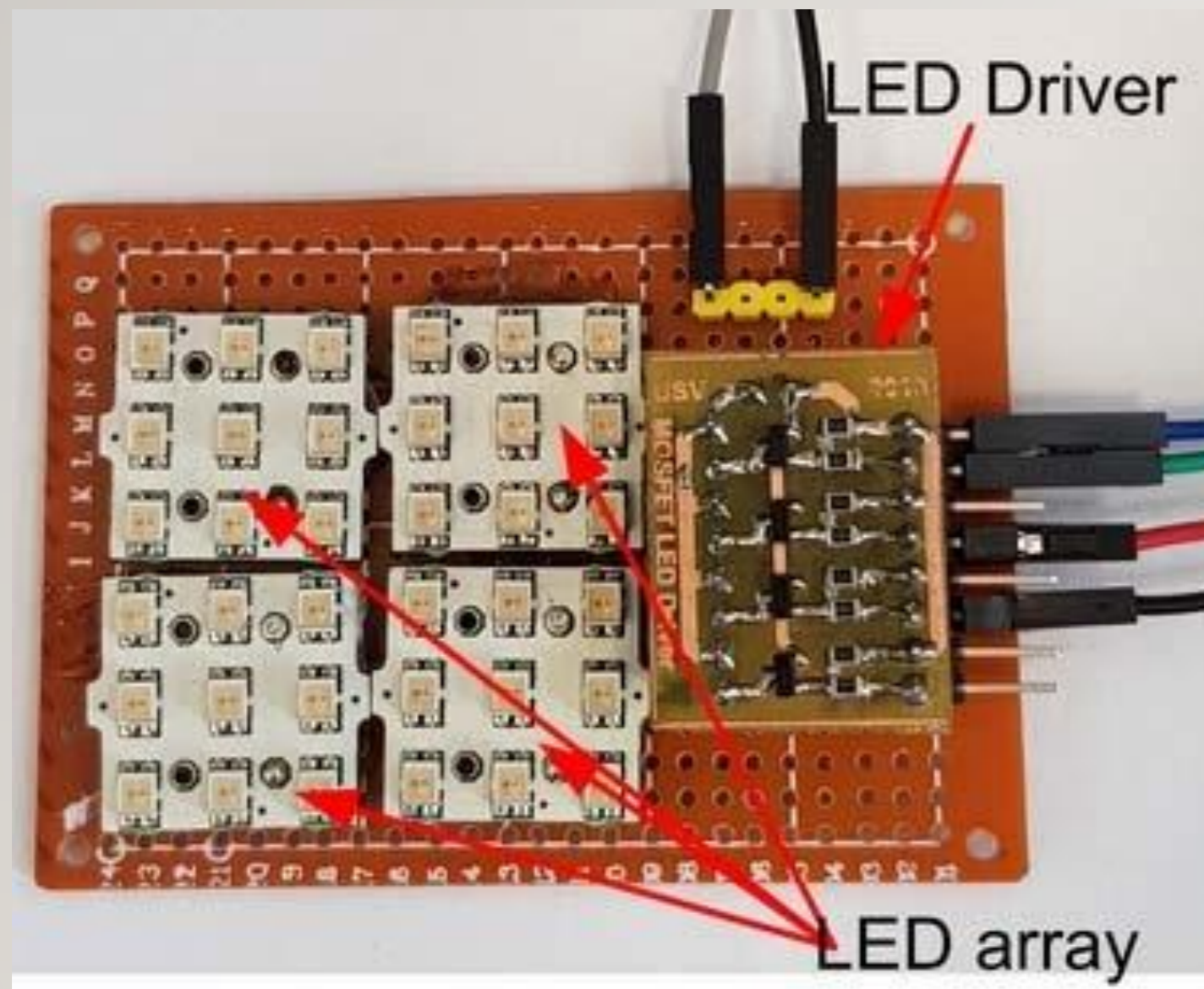

TRANSMITTER VLC

Tabel Perbandingan LED

Parameter	Pc-LED	RGB LED	uLED	OLED
Kompleksitas	Rendah	Medium	Sangat Tinggi	Tinggi
Aplikasi Khusus	Iluminasi		802.11	Display
Bandwidth	3 -5 MHz	10 – 20 MHz	> 300 MHz	< 1 MHz
Disipasi Daya	Rendah	Tinggi	Rendah	Sangat Terjangkau
Harga	Rendah	Tinggi	Rendah	Sangat Terjangkau

RECEIVER VLC

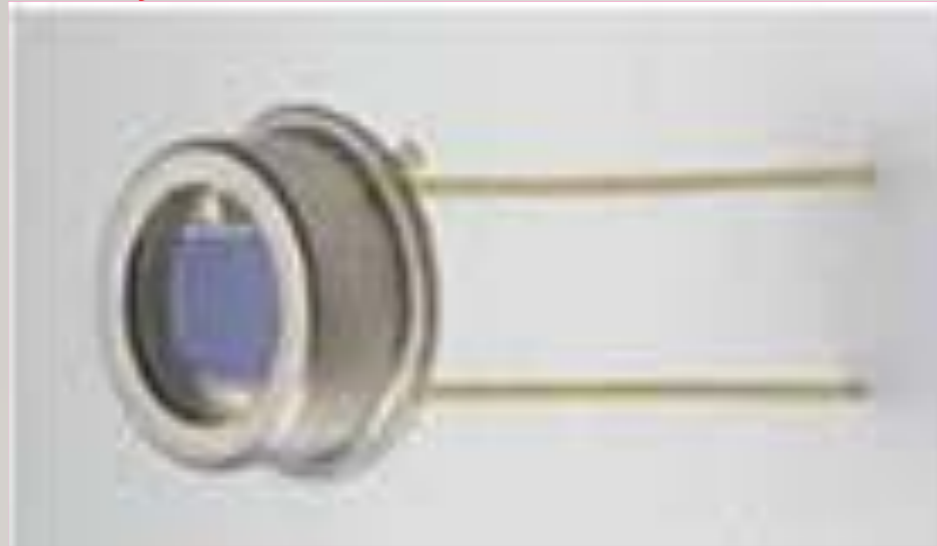

❑ PIN photodiode

- ❖ Harga Murah, Area Pancaran Luas
- ❖ Sensitivitas Terbatas

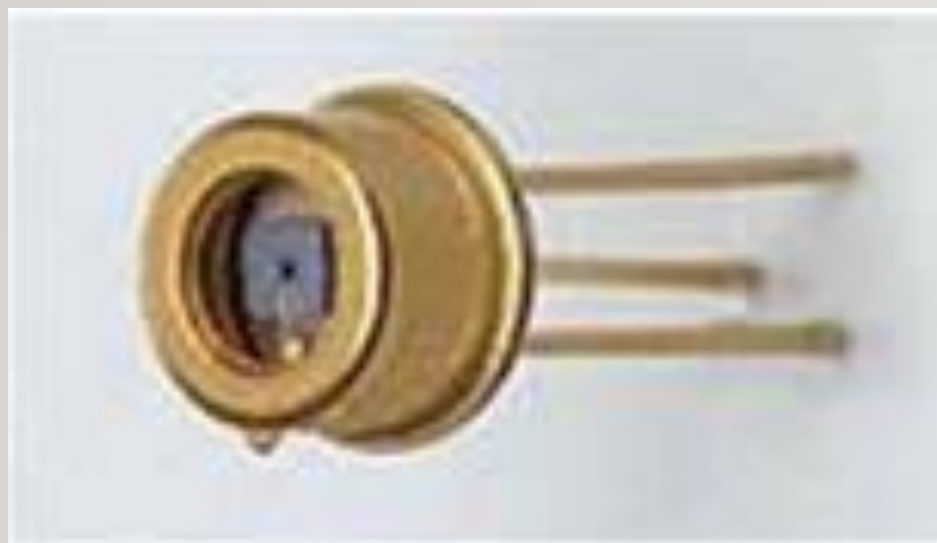

❑ Avalanche photodiode (APD):

- ❖ Sensitivitas Yang Lebih Tinggi, Area Yang Lebih Kecil
- ❖ Reverse Bias Tinggi → Biaya Jauh Lebih Tinggi



❑ Image sensors:

- ❖ **CCD type:** Biaya Rendah Karena Volume Tinggi, Lambat Karena Pembacaan Serial

KANAL VLC

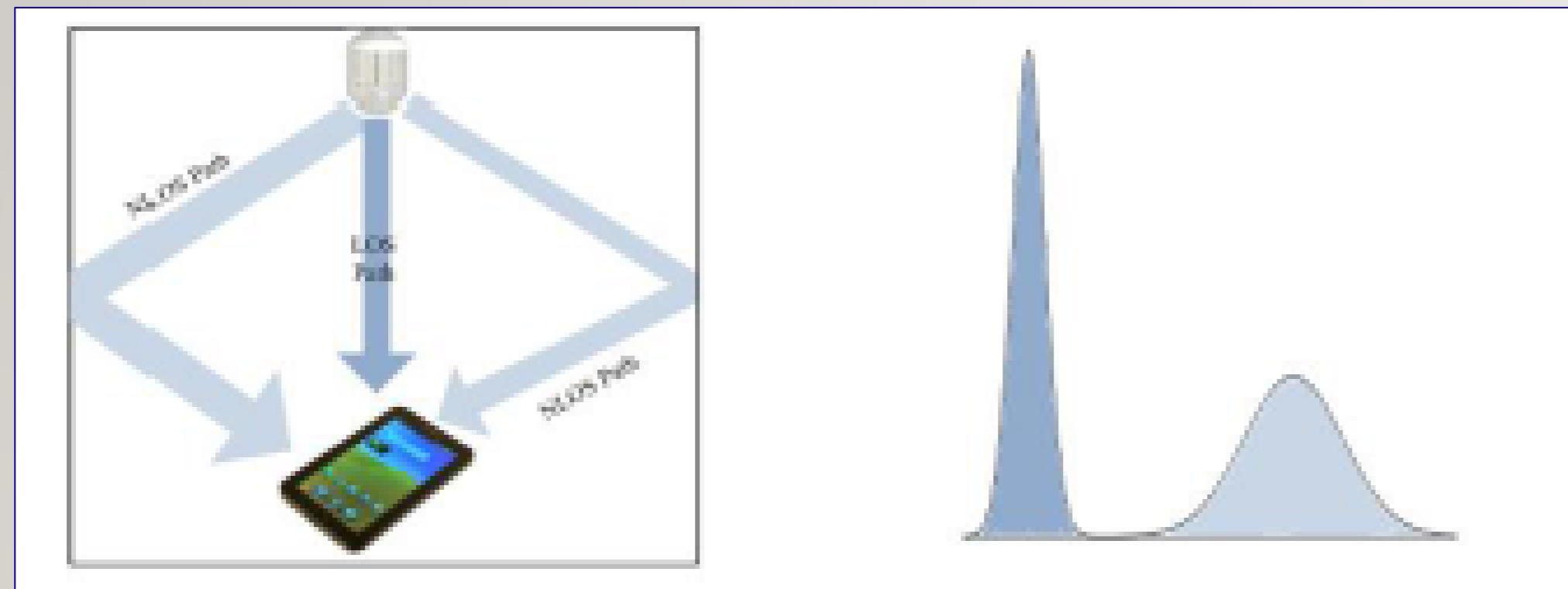

GAMBAR. KANAL LINE OF SIGHT (LOS)

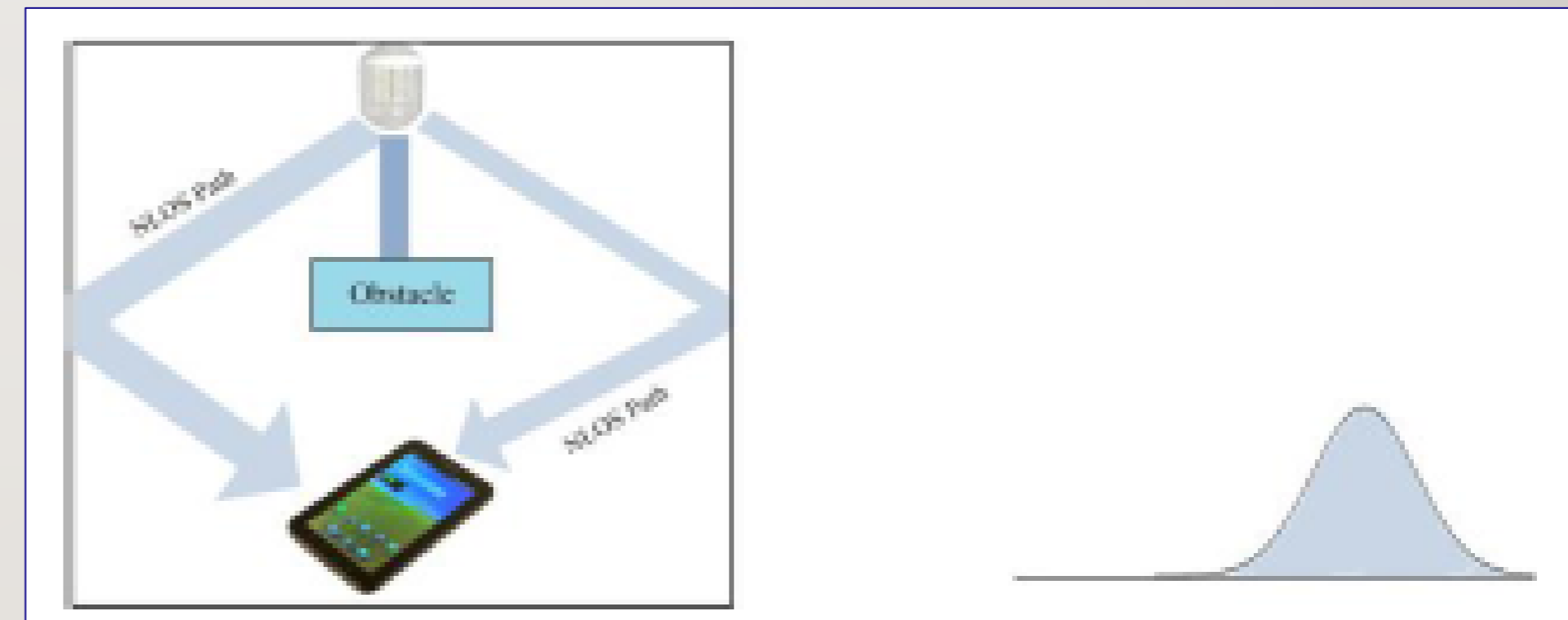

GAMBAR. KANAL NON LINE OF SIGHT (NLOS)

KANAL LINE OF SIGHT (LOS)

KEKURANGAN

KELEBIHAN

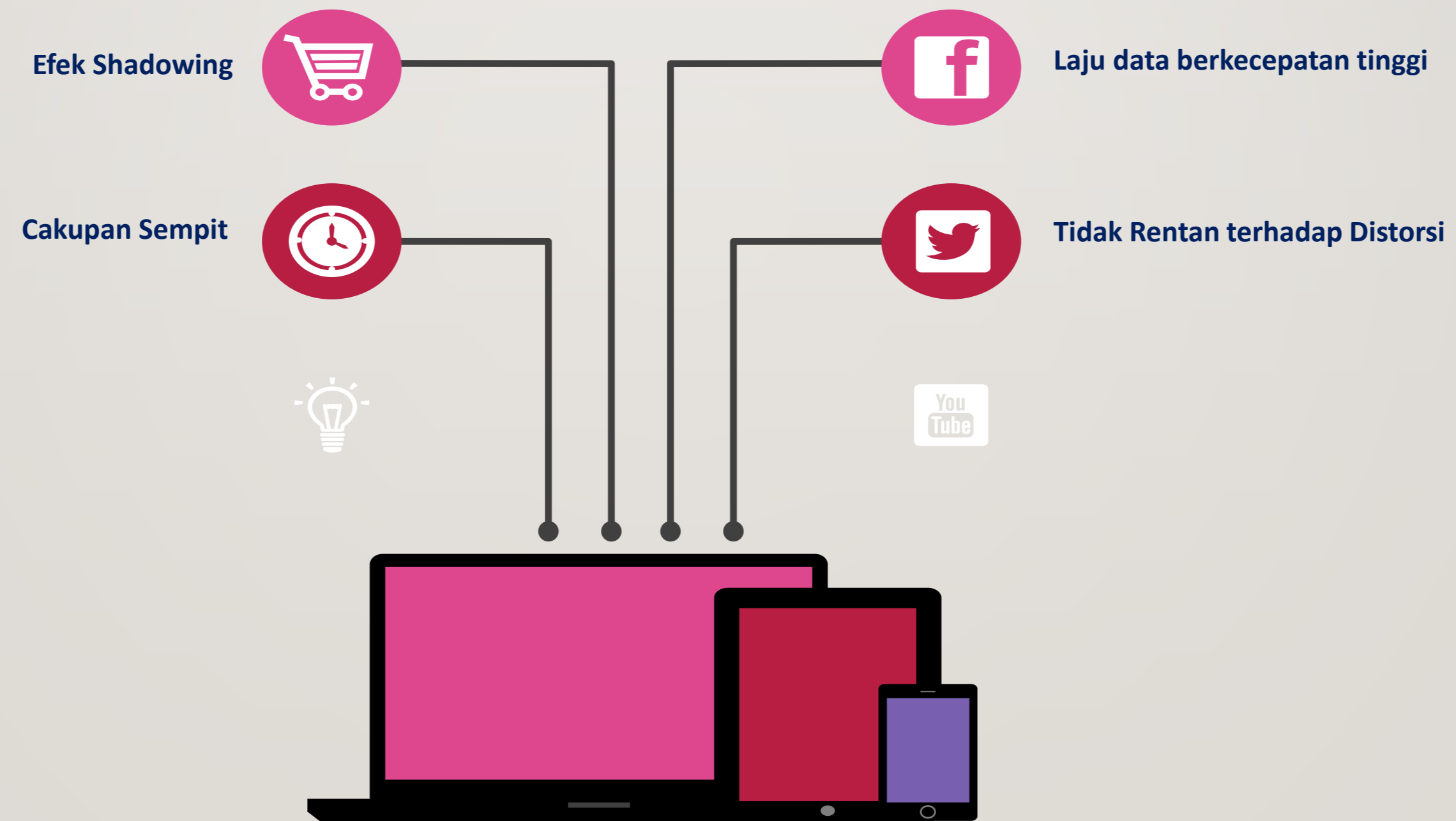



TERIMA KASIH



UNITED STATES OFFICE

1243 Barker Cypress
San Francisco, California



EUROPE OFFICE

13 Ave. Ballarta
Barcelona, Spain



SOUTH AMERICA OFFICE

45 Calle Norte
Argentina